

A

B

C

D

E

F

G

H

左側面図

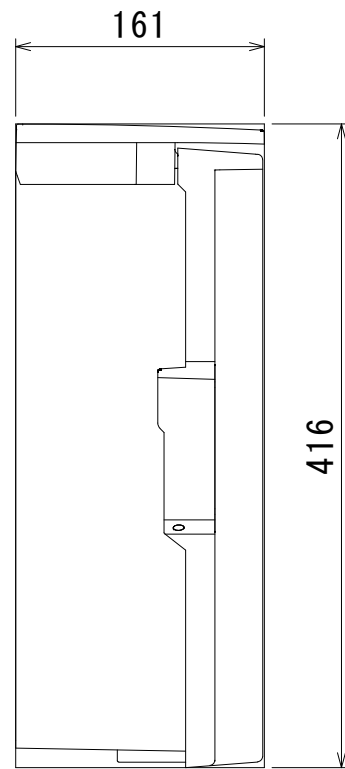

正面図

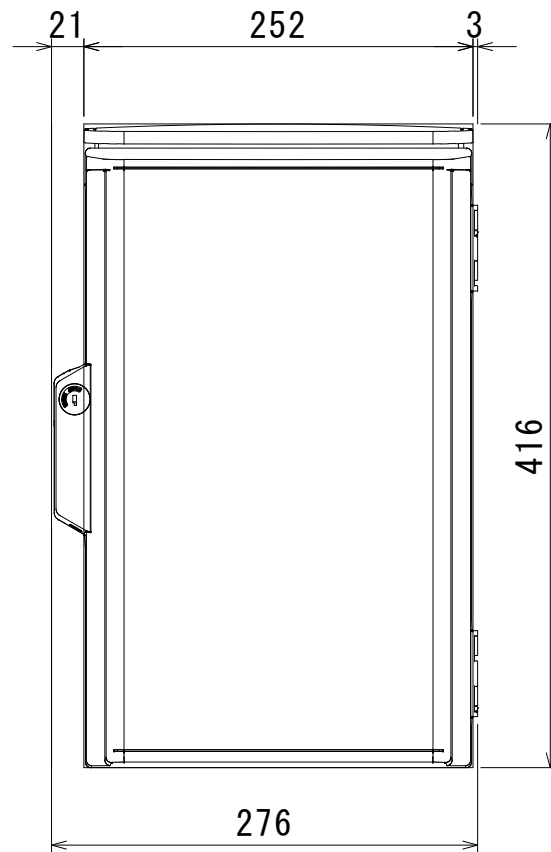

右側面図

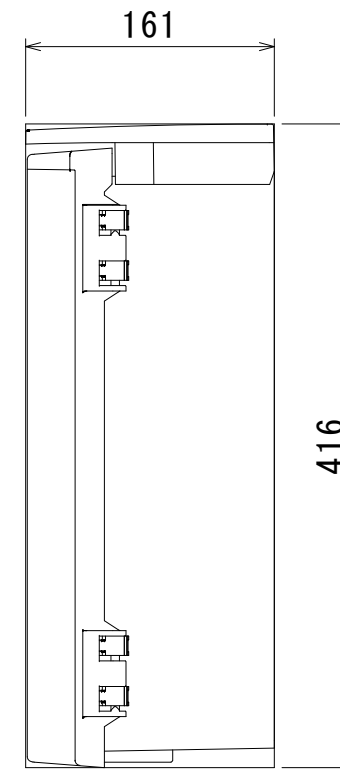

底面図

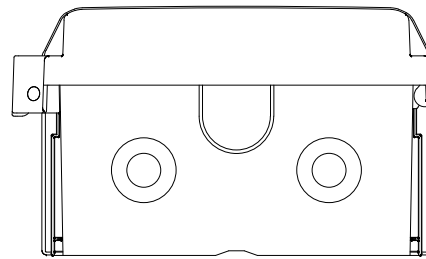

盤重量 4 kg

構造	屋外防塵型
材質	ボディー AAS樹脂 2.5 t
	扉 AAS樹脂 2.5 t
	中板 木製 1.5 t
塗装色 内外共	ホワイトグレー
	マンセルN8.5

Revisions

	Date	Name
Drawn	25/10/31	清水
Checked	25/10/31	横井

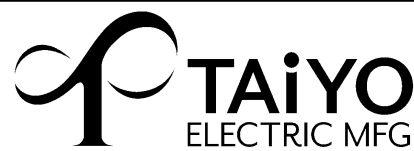

Title

T - B o く ん
外形図

Ref. Dwg. No.

H025-####-1

2

A

B

C

D

E

F

G

H

A

B

C

D

E

F

G

H

正面図

C-C断面図

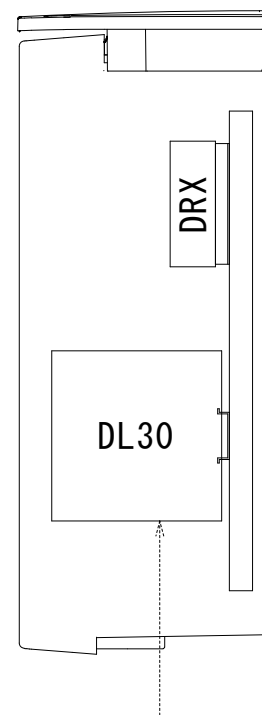
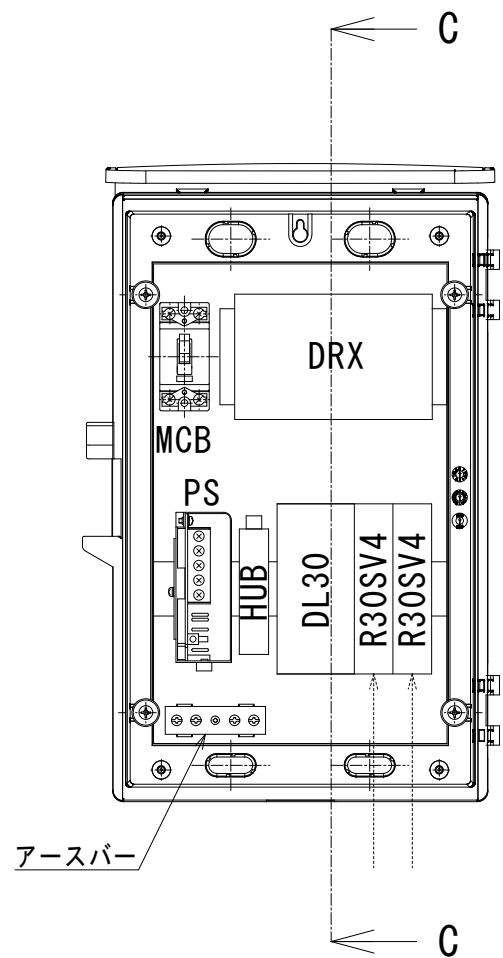

Revisions

	Date	Name
Drawn	25/10/31	清水
Checked	25/10/31	横井



Title

T - B o く ん
内部配置図

Ref. Dwg. No.

H025-####-1

3

A

B

C

D

E

F

G

H

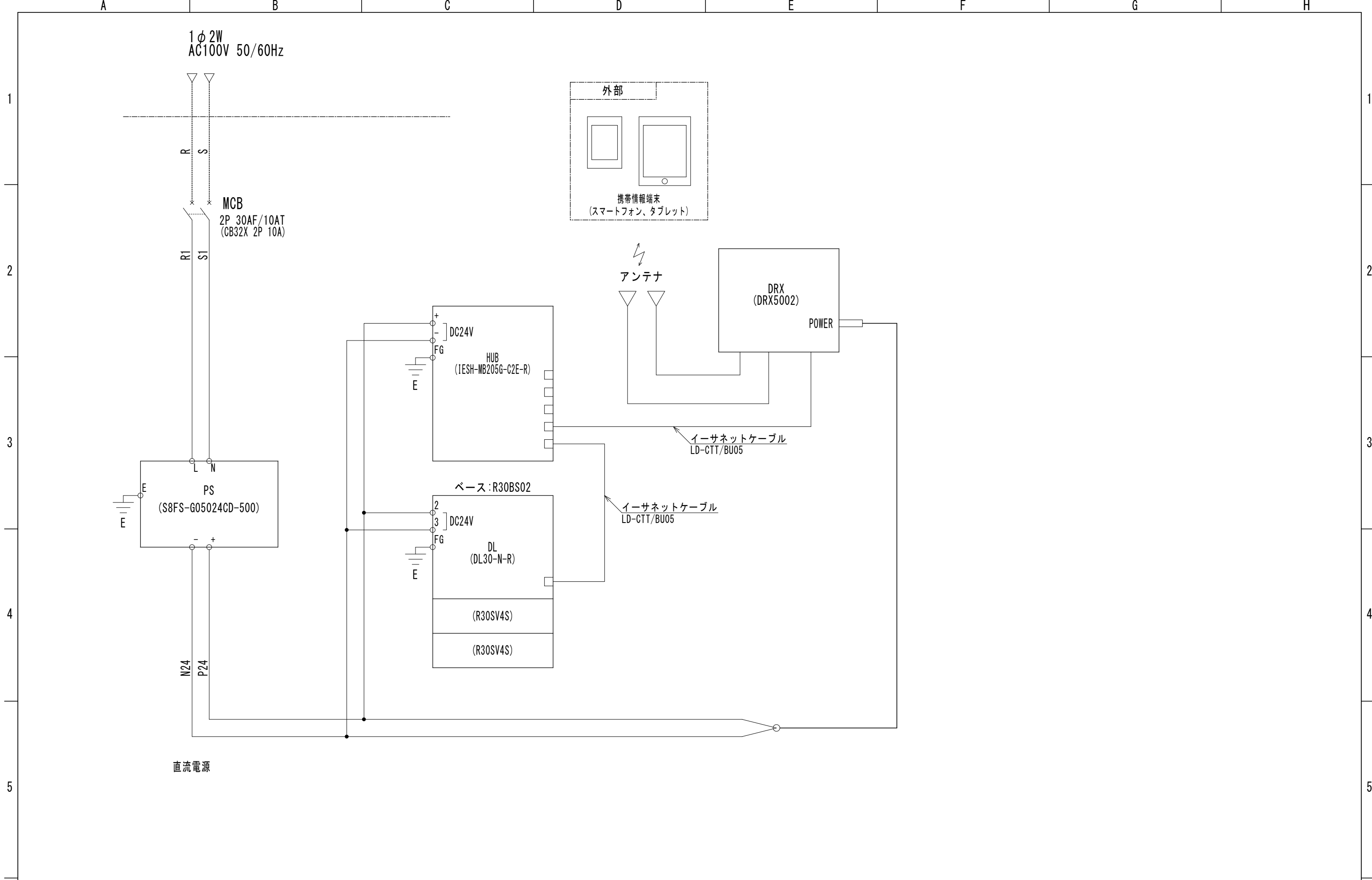

Revisions

		Date	Name
	Drawn	25/10/31	清水
	Checked	25/10/31	横井



Title

T - B o く ん
制御回路

Ref. Dwg. No.

H025-####-1

5

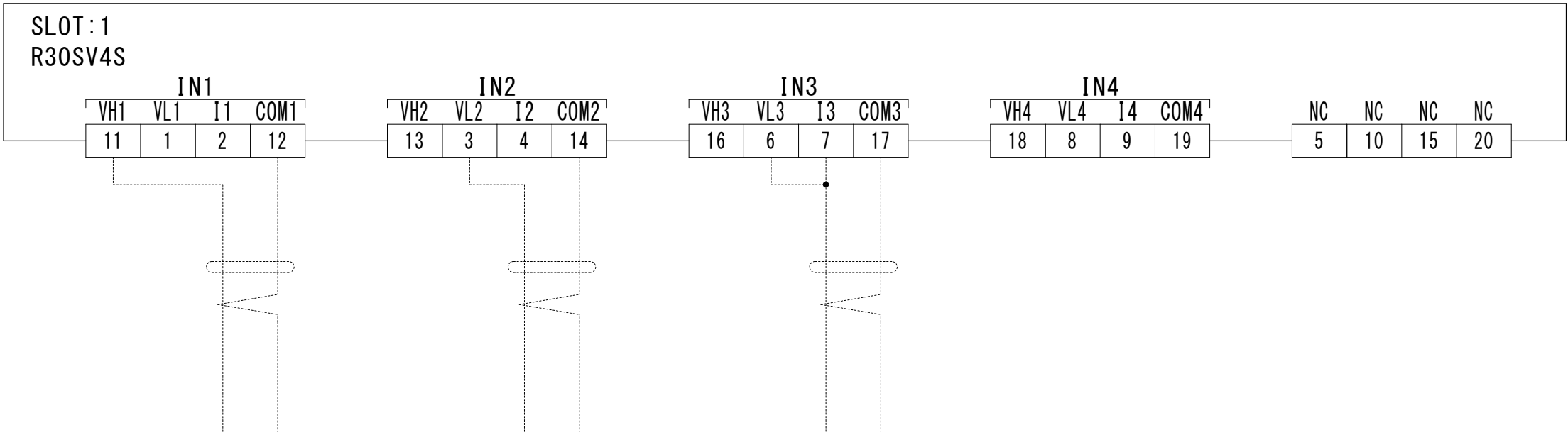

高電圧レンジ入力
(-10~+10V DC)

低電圧レンジ入力
(-1~+1V DC)

電流レンジ入力
(-20~+20mA DC)

(*****)

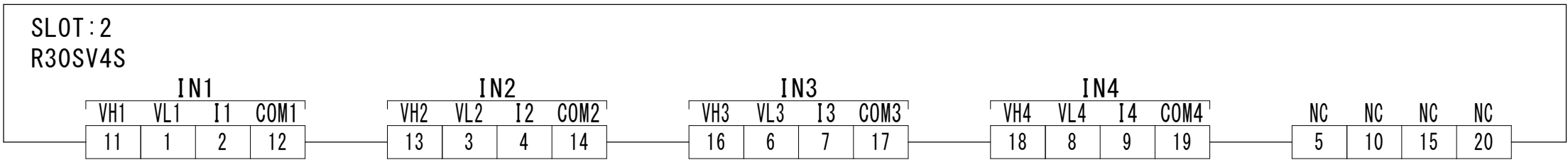

(*****)

(*****)

(*****)

(*****)

Revisions

	Date	Name
Drawn	25/10/31	清水
Checked	25/10/31	横井



Title
T - B o < n
制御回路

Ref. Dwg. No.	H025-####-1	6
---------------	-------------	---